

MULTI-RAT BASED ADAPTIVE QUALITY OF SERVICE (QoS) MANAGEMENT IN WBAN

Tayyaba Irshad¹, Rafi-us-Shan^{2}, Raja Wasim Ahmad³, Abbas Khalid⁴, Siti Hafizah Ab Hamid⁵*

^{1,2,3,4} Department of Computer Science, COMSATS Institute of Information Technology, Abbottabad, Pakistan

⁵ Faculty of Computer Science and Information Technology, University of Malaya, Kuala Lumpur, Malaysia

Email: comsian.tyba@gmail.com¹, shan@ciit.net.pk^{2*} (corresponding author), wasimraja@ciit.net.pk³, abbaskhalid@ciit.net.pk⁴, sitihafizah@um.edu.my⁵

DOI: <https://doi.org/10.22452/mjcs.vol33no4.1>

ABSTRACT

Wireless body area network (WBAN), a sub-branch of wireless sensor networks (WSN), helps continuous monitoring of various conditions and states of a human body. It has vast application areas, including self-care, battlefield, health, sports, assisted living, and entertainment. In WBAN, sensors (e.g., ECG, EEG, EMG, and temperature) may transmit sensed information of the subject under observation to a personal server which directs it to the main server for the analysis. The requirement of an application in terms of reliability and delay varies depending on the situation and environment. For instance, the high network delay and jitter for a health application may lead to a human death due to urgent response requirement. The major challenge faced by WBAN is to offer high Quality of Service (QoS). To ensure high QoS in WBAN, different techniques are proposed but all these techniques have considered different layers for different radio technologies. The current study put forwards an adaptive Multi-Radio Access Technologies (multi-RAT) based platform for the WBAN. Multi-RAT proposes a convergence/adaptation layer to entertain increasing request rate of WBAN applications. As a result, throughput, delay, and blocking probability for each request are minimized.

Keywords: *Convergence Layer, Heterogeneous Environment, Multi-RAT, QoS*

1.0 INTRODUCTION

WBAN is a network of wearable devices that autonomously operates to connect medical sensors attached to the human body. It offers numerous exciting applications for self-care, remote care, home medical care, and entertainment services. The examples of self-care services include sports, health, diet, and beauty; whereas, home medical care applications consist of ECG, blood pressure, breathing, and body temperature sensors to provide the required services [1-2]. WBAN is a special type of WSNs. The key characteristics of WBAN and its applications include, no redundant nodes, low transmit power per node, lossy and unpredictable propagation channel, in time and ordered delivery of packets having special delay requirements [3-4].

WBAN is considered as a heterogeneous environment owing to internetworking of dissimilar communication technologies often known as multi-RAT (Radio Access Technologies). The main motivation for the heterogeneous network design for a WBAN is the varying and dissimilar requirements of applications (e.g., medical care and disaster services). The sensors used in a WBAN offer dissimilar data rates, queuing delays, and data capturing interval due to the high difference in their architectural designs and vendors. Table I has highlighted data rate, profiling time interval, and a threshold value for a set of sensors.

Irrespective of physical characteristics of the wireless sensors, there are some special requirements for WBAN applications known as Quality of Service (QoS) constraints. For different applications of a WBAN, sensor requirements may differ according to the scenario or application. For instance, to closely monitor the patient' state, tiny sensors are embedded in dress or implanted in human body to constantly sense the different body states such as body temperature, blood pressure, heart beat rate, and pulse rate [15]. Alternatively, considering Public Safety systems, temperature sensors are used to notify the fire brigade workers about the surrounding temperature. In both the aforementioned cases, same sensors might have different QoS requirements according to the severity of the situation [16] [17].

Major technologies used in WBAN formation include Bluetooth, ZigBee, Medical Implant Communication System (MICS), and Ultra Wideband (UWB). During the scenario investigation, the selection of a particular technology truly depends on the application requirements [18]. All the aforementioned technologies have different features in terms of data rate, coverage area, operating frequency bands, and modulation schemes as highlighted in Table 2.

Table 1: Characteristics of Sensors [5-14]

Sensor	Data Rate	Profile Time Interval	Average Value (Threshold Value)
ECG	144kbps	10 sec	70bpm
EEG	100kbps	20 sec	Above 7Hz
Blood Pressure	144kbps	1 min	80mmHg-120mmHg
Blood Oxygen Saturation	16bps	1 min	97-98%
Glucose	1.6kbps	5 sec	100mg/dL-70mg/dL
EMG	320kbps	10 sec	200Hz-1KHz
Temperature	2.4bps	0.05 sec	1°F-98.6 F 0.6°C-37°C
Artificial Cochlea	200kbps	N/A	N/A
Audio	50-100kbps	N/A	N/A
Video/Medical Imaging	<1Mbps	N/A	N/A

Different radio access technologies have different features; but, these technologies cannot be provided within a single sensor because of their size constraints. In WBAN, a sensor is deployed inside a human body; therefore, an individual sensor cannot be forsaken to cope QoS and resource scarcity issues. Existing methods are not adaptive towards human body movement in order to perform well in different conditions. To cope with the QoS issues and to manage resource scarcity different solutions and schemes have been proposed. This paper presents a solution to cater QoS requirements i.e. delay, throughput, and blocking probability and augmenting the resource scarcity issue while taking into consideration WBAN special requirements in terms of sensor size and human body movement. The main contributions of this study include

- a. Proposing a convergence layer for WBAN to opt Multi-Rat technologies to adaptively select suitable network channels to meet the requirement of applications.
- b. Simulating the proposed technique in MATLAB tool to validate it for throughput, latency, and blocking probability of underlying network technologies.

The rest of the paper is organized as follows: Section 2.0 and Section 3.0 discuss Background and Related Work and illustrates special requirements of WBAN and different QoS solution for WBAN. Section 3.0 discusses the proposed model and its functionality. In Section 4.0 performance metrics and simulation results has been discussed. At the end of section 5.0 conclusion and future work is mentioned.

Table 2: Multi-RAT Comparison

Radio Technology	Data Rate	Frequency Band	Coverage Area
Bluetooth	1Mbps	2.4GHz	<10m
ZigBee	250Kbps	868MHz-2.4GHz	<100m
UWB	10Mbps	402MHz-2.4GHz	<5m

2.0 BACKGROUND

This section discusses special requirements of WBAN as compared to WSN. It highlights main features of WBAN. In WBAN, communication pattern among nodes and server is different in comparison to WSNs as they are specifically designed for monitoring of human body. In WBAN, sensors are implanted on a human body. As a result, for WBAN, each node's responsibility, channel characteristics, signal propagation between the nodes, computational

power, battery power consumption, storage, QoS requirement, and security aspects require more attention than WSNs. Given below is a list of features that differentiate WBAN to WSN.

- a. WBAN nodes are small in size (usually less than 1 cm³) [19]. As a result, the nodes carry limited computational power and energy budget. However, considering the severity of WBAN based applications, long network lifetime is a priority.
- b. A node within a WBAN has different responsibilities; therefore, each node has its own importance.
- c. To cope attenuation and interference issues, high frequency cannot be used as it may harm human cells. Therefore, in WBAN, the low power signal is required [20].
- d. In WBAN, sensors are implanted on a human body that frequently moves and changes its location. Therefore, for WBAN, the avoidance of transmission interruption during movement is a top priority while considering its architectural design [21].
- e. For human health based applications such as ECG, communication between sensors must be very fast and highly reliable.

The increment in a number of low-power and small size sensors deployed on, in or around the body enables specialists and medical caretakers to remotely screen has supported the enthusiasm for of checking applications in WBAN. By the expansion in a number of medicinal services applications, there is a critical need to satisfy the QoS prerequisites of the framework as WBAN add to extra QoS performance issues, particularly in the subject of medical monitoring applications. Be that as it may, QoS outline in WBAN is a challenging issue because of a few reasons, for example, lossy channel, resource scarcity and priority administrations. Another real issue is dealing with a need of parcels since need of bundles for various sensor hubs in WBAN is firmly identified with the connected medicinal application and patient conditions.

Besides, heterogeneity in sensors, different data rates and varying profile time intervals makes it hard to deal with the system design. For the most part, the information rates in WBAN are either low or high as specified in Table 1. Variety in information rates and profile time intervals makes resource assigning difficult in WBAN since high information rate sensors may surge the channel with their transmission and sensors with long time profile intervals will possess the channel for long time which in result will affect the transmission of low information rate sensor nodes and brief time profile interim sensors because of asset starvation.

3.0 RELATED WORK

The researchers have proposed many solutions to address the special requirements of WBAN. However, the existing literature revolves around proposing different communication technologies while considering a specific layer such as, MAC layer, network layer, and transport layer. Given below is a brief description of existing literature.

In [22], J.Yoon et al. have proposed a mechanism for prioritizing network traffic based on preemptive slot allocation and non-preemptive transmission slot allocation. In the proposed study, traffic is divided into three classes including emergency data, continuous data, periodic and non-periodic data. Furthermore, it has followed the super-frame structure having five periods: collision access period, beacon, data transmission slot, and last for emergency data. Considering Time Division Multiple Access (TDMA), slots are preempted by emergency traffic on the basis of a beacon transmitted by priority coordinator. The proposed study has catered the QoS parameter such as priority mapping.

In [23], Khaled A.Ali et al. worked on a priority mapping mechanism while considering two classes in medical health applications: life-critical and non-critical health information. According to this mechanism nodes having critical information are given high priority and they can contend for medium while non-critical aren't. In the proposed study, a threshold value was estimated to represent the severity of the data. It follows the IEEE 802.15.4 superframe structure. The mechanism handles the priority mapping.

In [24], H.Cao et al. proposed a mechanism of traffic classification on the basis of QoS parameters application priority, arrival rate, and available burst size. Targeted network for this mechanism is IEEE 802.15.4 following the superframe structure in beacon-enabled mode. Traffic of WBAN is classified into command data, alarm control, and routine traffic. Alarm control and command data follow CSMA/CA. Routine traffic uses collision free periods as it is in heavy volume. Scheduler decides to issue collision free slots on the basis of network parameters and traffic priority to handle energy efficiency. It caters the QoS parameters i.e. traffic priority and energy efficiency.

In [25], M. Barua classified the WBAN traffic into two classes' real-time and non-real time traffic. Real-time traffic needs less delay as compared to other class. Real-time traffic is further classified into queues based on weighing factor in terms of QoS parameters high-priority and low priority queues. High priority queues are served higher and scheduler accepts packets for service when running process has finished.

In [26], Shih Heng Cheng et al. proposed a multiuser QoS design for WBAN. The proposed solution consists of two designs: a central processing based random contention-based central processing node (CPN) negotiation and resource allocation. In first method, other nodes communicate to central processing node for resource allocation and in second method two CPN of inter-BAN negotiate for resource management i.e. bandwidth allocation and user priority. Hence it provides multi-user QoS. It caters the QoS parameters latency, energy efficiency, user capacity and priority mapping and interference between BANs while making CPN negotiable.

In [27], Mohammad Mostafa Monowar et al. proposed a MAC protocol handling the diverse requirements of WBAN MAC protocol with multiple constraints of delay and reliability. It classifies the traffic into four types: emergency, delay, and reliability constrained data, reliability constrained but not delay constrained data, delay constrained but not reliability constrained data. Emergency traffic has hard QoS requirements while the second type has soft QoS requirements. The other two types are compromising on any one of the mentioned requirements delay or reliability. This mechanism works on a superframe structure following the rule "transmit-when-ever-appropriate" divided into Contention-free period (CFP), contention access period (CAP), prioritized contention access period (PCAP). Proposed scheme caters the QoS parameters delay, reliability, priority mapping, and energy efficiency.

In [28], Mohsin Iftikhar et al. proposed a novel technique for QoS provisioning of multimedia traffic in WBAN. In traditional networks, traffic pattern follows the Poisson distribution model but in WBAN traffic pattern changes according to the scenario and application criticality. It classifies the multimedia traffic into three classes critical, streaming and non-critical traffic on the basis of previous states saved and a pattern is followed by Hidden Markov Model. In this technique priority of traffic is set on the basis of previous state saved. A chain of states is established to predict its priority in next cycle. It handles the QoS parameters i.e. priority mapping, resource allocation and energy efficiency.

In [29], Smita Bhoir et al. proposed an improved version of WBAN MAC protocol which considers energy as a specific requirement in WBAN. It is based on ALOHA protocol which distinguish various types of sensor data based on emergency. In order to minimize packet collision, overhearing, idle listening and control packet overhead problem power efficient and flexible duty- cycling techniques are required. In this proposed work normal traffic operates in Aloha and slotted-aloha is used for on-demand and emergency traffic. A central coordinator synchronizes all the nodes. It sends an acknowledgement to give the guarantee of delivery of data. It considers the QoS parameters i.e. priority mapping, energy efficiency and resource allocation.

In [30], Kyoung Hur proposed a QoS technique for WBAN IEEE 802.15.6 for multimedia traffic in WBAN considering traffic load and priority of requests. It allocates time slots for multimedia traffic streams executing at equal time intervals according to current traffic load. On this base time slots will be allocated on the basis of the proposed algorithm. The algorithm checks the satisfaction ratio of QoS on the basis of traffic load, queuing delay and minimum and maximum bandwidth requirements. It considers the QoS parameters i.e. Priority mapping and resource allocation.

In [31], Madumitha et al. proposed a mechanism to improve QoS on transport layer. In this technique, three QoS modules are proposed: Packet handling module, reliability module, and congestion control module. These three modules ensure QoS by different procedures. Packet handling module has sub-modules i.e. packet classifier, packet scheduler, packet buffering and packet dropping modules. It classifies the packets and drops the packets on the basis of priority level. Reliability module has sub-modules i.e. packet reordering module, loss recovery module, duplicate handling module. It reorders the packets and recovers the lost packets. The third module Congestion control module has sub-modules like congestion detection, notification and avoidance module. It controls the congestion on the channel in order to ensure QoS. It caters the QoS parameters priority mapping and resource allocation.

In [32], Flavia Martelli et al. proposed a link adaptation scheme for IEEE 802.15.4 using CSMA/CA technique. Different modulation schemes are considered at the physical layer which provides opportunity for application to choose from them. Link adaptation is based on the channel quality and query by the application. The coordinator sends a beacon to concerned nodes. Nodes calculate the power received and estimates the Signal to Noise Ratio (SNR) which leads to channel adaptation between nodes and coordinator. This scheme works for query-based

applications in contention based network to reduce packet loss. The proposed work considers the QoS parameters i.e. priority mapping, reliability, and packet loss.

In [33], Mohammad Sadegh Mohammadi et al. proposed a QoS mechanism based on link adaptation scheme for WBAN IEEE 802.15.6 IR-UWB. It adapts the modulation and coding schemes based on energy efficiency and packet success rate estimation on receiver side for different physical layer modes. It considers the QoS parameters i.e. energy efficiency, packet loss. Adaptation is followed by non-coherent data patterns by modeling bit error probability on different physical layers. Management and control frames are used to adjust PHY parameters. Major parameters for adaptation of modulation schemes and PHY modes are energy efficiency and bit error rate.

In [34] Tuomas Paso et al. proposed a link adaptation scheme for IEEE 802.15.4a UWB. In this scheme transmission of data from WBAN, Access Point to WBAN coordinator is considered. In IR-UWB there are two modulation schemes Burst Position modulation (BPM) and Binary-Phase Shift Keying (BPSK). MAC layer informs the PHY by control frame information bits about the modulation scheme required at the moment i.e. application priority, channel state. It checks for interference ratio by checking packet retransmissions. It caters the QoS requirements throughput, packet delivery ratio and packet delay along with priorities defined by the application layer.

In [35] Hongnian Yu, et al. worked on a specific aspect of QoS measures Delay, Reliability and Throughput (DRT) while considering communication technologies IEEE 802.15.4 and IEEE 802.15.6. Different operating frequency bands are also considered for IEEE 802.15.6 Wireless Body Area Sensor Networks (WBASN). To calculate reliability packet delivery ratio is considered theoretically and numerically for different modulation schemes under different operating frequency bands.

In [36] M. Javaid et al. considered delay as a major QoS parameter for medical and remote care applications. This work considers data transmission from sensor to health-care center over a heterogeneous wireless channel for a multi-hop network. Data from sensor is transmitted via ZigBee and further delay sensitive path is chosen from heterogeneous wireless technologies WiMAX, UMTS, and Zigbee. The transmission link is chosen on the base of minimum delay.

In [37] Long Hu et al. proposed a mechanism which centers around QoS provisioning of sensors data at different levels in WBAN for IEEE 802.15.4 beacon-enabled mode. It utilized tree topology as it is adaptable for large scale systems. As per this component, a switching hub amongst node and coordinators changes progressively as per moment need terminal sensor nodes, which allows restricted transmission capacity for conveying information among various patients sharing a single coordinator. This paper classifies traffic priorities according to priorities indicated by a user, information/data and time: Priority of User (PoU), Priority of Data (PoD), and Priority of Time (PoT). It caters QoS requirements priority, delay and reliability.

In [38] Sbaïn Bhandari et al. worked on QoS parameters including throughput, delay and energy consumption while considering unlicensed band which assigns time slots progressively in light of activity need or priority of sensor. It groups movement into four classifications: emergency traffic, on-demand, normal and non-medical traffic. Two channels for information transmission, for example, signal channel and information channel were considered. Beacon-enabled channel is utilized for transmitting and getting beacon frames while information channel is considered for rest of correspondence. Moreover, various channels are adequately used to get to delays in WBAN, in the presence of other existing frameworks.

In [39] Yangzhe Liao et al. proposed a QoS mechanism to increase network lifetime, throughput and decreasing delay. Bit error rate (BER) performance for various modulation schemes i.e. BPSK, QPSK, 16 QAM and 16 PSK is tried for various Bit error rates (BER) of 10^{-3} for two types of traffic heavy load and light load. This paper additionally examined a connection between information transmission rates, transmitting power and achievable communication distance is discussed about under connection cost estimation.

In [40] Farhan Masud et al. proposed an adaptive MAC protocol in WBAN for improving packet delivery ratio and energy consumption as well as decrement in delay while taking into consideration IEEE 802.15.4 and IEEE 802.15.6. It has classified the traffic into two categories routine traffic as low-load traffic, alarming situation traffic as high-load traffic.

In [41] Jaeeo Lee et al. proposed an emergency-prioritized mechanism for improving QoS in IEEE 802.15.6. As per proposed mechanism coordinator synchronizes different nodes against collisions, energy consumption and interference. It needs to adaptively control the excessive energy consumption by making adjustments amongst

coordinator and nodes. This paper worked on two sorts of traffic: periodic report data and emergency data. Proposed mechanism limits conveyance delay for transmission of emergency data and adjusts energy among coordinator and nodes. Consequently, it caters delivery delay and energy efficiency for energy-constraint wearable devices in WBAN.

A comprehensive comparison of different QoS techniques is mentioned in Table 3.

Table 3: Comparison of QoS Techniques in WBAN

Publication	Year	Targeted Network	QoS Parameters		
			Priority Mapping	Resource Allocation	Delay
Pnp-mac	2010	IEEE 802.15.4	Yes	No	No
QoS-based MAC protocol for Medical Wireless Body Area Sensor Networks	2010	IEEE 802.15.4a	Yes	No	No
Employing IEEE 802.15.4 for quality of service provisioning in wireless body area sensor networks	2010	IEEE 802.15.4/ Beacon Enabled	Yes	No	No
Secure and quality of service assurance scheduling scheme for WBAN with application to ehealth	2011	-	Yes	Yes	No
RACOON: A Multiuser QoS Design for Mobile WBAN	2011	IEEE 802.15.4	Yes	No	No
McMAC: Towards a MAC Protocol with Multi-Constrained QoS Provisioning for Diverse Traffic in WBAN	2012	IEEE 802.15.4	Yes	No	Yes
Analyzing Delay in Wireless Multi-hop Heterogeneous Body Area Networks	2013	IEEE 802.15.4a	No	No	Yes
A Novel Analytical Model for Provisioning QoS in Body Area Sensor Networks	2014	-	Yes	Yes	No
An Improved WBAN MAC Protocol	2014	IEEE 802.15.4	Yes	Yes	No
A Hierarchical MAC Protocol for QoS Support in Wireless Wearable Computer Systems	2014	IEEE 802.15.6	Yes	Yes	No
Transport Layer Protocol for WBAN system	2014	-	Yes	Yes	No
Link Adaptation in WBAN	2011	IEEE 802.15.4	Yes	No	No
Optimal Energy Efficiency Link Adaptation in IEEE 802.15.6 IR-UWB BAN	2014	IEEE 802.15.6	Yes	No	No
Novel Modulation Adaptation Techniques for IEEE 802.15.4a UWB System	2014	IEEE 802.15.4a	Yes	No	Yes
Design of QoS-Aware Multi-Level MAC-Layer for Wireless Body Area Network	2015				
Delay, Reliability, and Throughput Based QoS Profile : A MAC Layer Performance Optimization Mechanism for Biomedical Applications in Wireless Body Area Sensor Networks	2016	IEEE 802.15.4a	Yes	No	Yes
A Priority-Based Adaptive MAC Protocol for Wireless Body Area Networks	2016	IEEE 802.15.4	Yes	Yes	Yes
Analysis of In-to-Out Wireless Body Area Network Systems: Towards QoS-Aware Health Internet of Things Applications	2016	-	No	Yes	Yes
Traffic adaptive MAC protocols in wireless body area networks	2017	IEEE 802.15.4 & IEEE 802.15.6	No	No	Yes
Emergency-Prioritized Asymmetric Protocol for Improving QoS of Energy-Constrained Wearable Device in Wireless Body Area Networks	2018	IEEE 802.15.6	Yes	No	Yes

4.0 PROPOSED SYSTEM MODEL

The traditional WBAN based approaches have considered different communication technologies to handle QoS for WBAN applications. However, they overlooked combining multiple Radio Access Technologies for WBAN to service the application's requests. Considering WBAN, it consists of three major components including sensors, personal server, and main/medical server. Our proposed technique has focused on improving QoS across personal server and main/medical server. To improve the QoS, we have proposed a convergence layer that lies on the personal server and communicates across personal server and main server for maintaining the required QoS for WBAN applications.

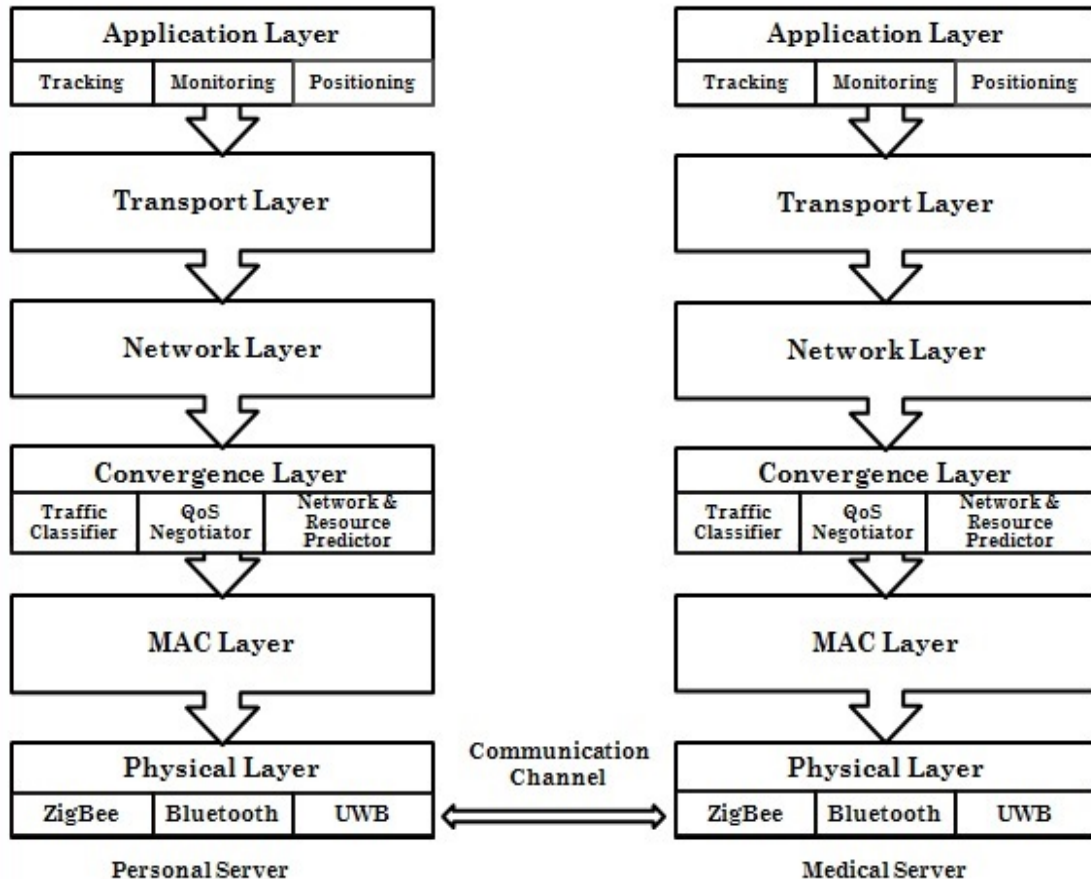

Fig 1: Proposed System Model

The proposed system model is a combination of following three different concepts: multi-RAT, channel aggregation, and rate adaptation.

The convergence layer supports Multi-RAT architecture to propose a simplified interface for WBAN applications while hiding the complexities of underlying technologies due to heterogeneity. Multi-RAT feature of proposed study increases the bandwidth to minimize the latency. It handles the allocation of appropriate RAT, spectrum aggregation, and rate adaptation across the selected RAT based on the requirement of application [42-46]. Rate adaptation feature tunes the modulation schemes to meet the QoS requirement request as specified by the application [46][47]. Given below is a brief overview of the functioning and interaction of convergence layer to other layers.

In the first step convergence layer collected data from the sensors. It analysis the data in an online fashion to decide the requirements of WBAN based applications. In the third stage, it initiates a resource allocation request to the underlying network technologies. The details of the communication among convergence layer and the other layers are discussed below in details.

Step a:

Application initiates communication and sends its parameters list to convergence layer (Management Information). The parameters include,

- i. Coverage area, Priority, Reliability and Throughput
- ii. Priority Mapping (i.e. Based on App decision)
- iii. Reliability (i.e. Data criticality in sense of value/format/sequence)

Step b:

After receiving application requirement, convergence layer communicates to the physical layer to inquire information about,

- a. Physical Radio Technologies
 - i. Available Frequency Band
 - ii. Available Data Rate
 - iii. Available Modulation Scheme
- b. Channel Quality Assessment
 - i. Signal to Noise Ratio (SNR) on Channels

For the current study, the considered technologies along their characteristics are given in Table 4.

Table 4: Metric Table of Multi-RAT

Standard	Frequency	Number of Channels	Modulation	Data Rate (kbps)
IEEE 802.15.4 ZigBee	779–787	4	O-QPSK	250
		4	MPSK	250
	868–868.6	1	BPSK	20
			ASK	250
			O-QPSK	100
	902–928	10	BPSK	40
			ASK	250
			O-QPSK	250
	950–956	12	GFSK	100
		10	BPSK	20
2400–2483.5	16	O-QPSK	250	
IEEE 802.15.6 Ultra Wide Band	402 -405 MHz	10	$\pi/2$ -DBPSK	75.9
			$\pi/2$ -DBPSK	151.8
			$\pi/4$ -DQPSK	303.6
			$\pi/8$ -D8PSK	455.4
	420- 450MHz	12	GMSK	75.9
				151.8
				187.5
	863 to 870 MHz, 902 to 928 MHz, 950 to 958 MHz	14	$\pi/2$ -DBPSK	101.2
		60	$\pi/2$ -DBPSK	202.4
		16	$\pi/4$ -DQPSK	404.8
			$\pi/8$ -D8PSK	607.1
	2360 to 2400 MHz, 2400 to 2483.5 MHz	39	$\pi/2$ -DBPSK	121.4
			$\pi/2$ -DBPSK	242.9
79		$\pi/4$ -DQPSK	485.7	
		$\pi/8$ -D8PSK	971.4	

IEEE 802.15.1 Bluetooth 2.4GHz	Asynchronous logical transport (ACL)		GFSK (Gaussian Frequency Shift Keying)	108.8
				172.8
				258.1
				390.4
				286.7
	Synchronous			433.9
				185.6
				64.0
	Data Voice Packet (Voice no Retransmission)			64.0
				64.0
				96
				192
				288
	64.0 + 57.6 Data			

Step c:

Convergence layer acquires the required data from the physical layer.

Step d:

It notifies the application layer and adjusts its parameters according to priority mapping and reliability.

Step e:

Application sends data as per the negotiated QoS parameters.

In the design of proposed model, the channel state is considered based on Channel Quality Information (CQI). We have defined three levels for priority and reliability setting of channels in the available channel pools. However, selection of suitable RAT depends on the coverage area required by the user mentioned in Table.2 as well as CQI of the available RATs for the available channels.

Following is the list of annotations used in explaining the working of system model.

Table 5: Annotations Used in System Model

Annotation	Description
C_A	Coverage Area in meters required to access the nearby Server
D.R	Data Rate
M	Modulation Scheme
NoC	Number of Channels
P_R	Priority required by application (High, Average, Low)
R	Reliability required by application (High, Average, Low)
CQI	Channel Quality Information
SNR	Signal to Noise Ratio
BER	Bit Error Rate
P.T	Profile Time Interval
D.R	Data Rate

Below Fig.2 is explaining the communication between Medical/Main Server of WBAN and sensors via Personal Server where convergence layer is implemented.

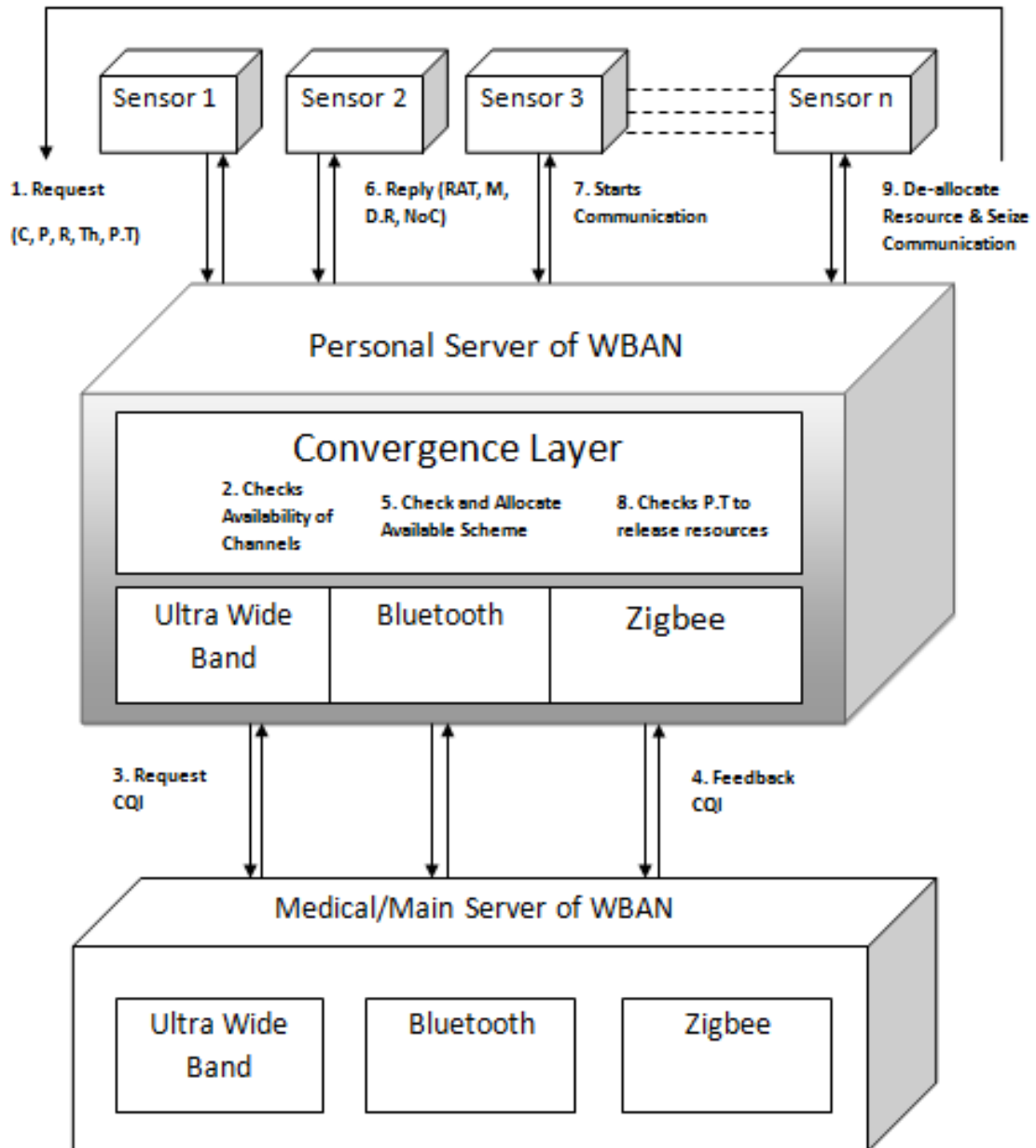

Fig 2: Convergence Layer Working

5.0 SIMULATION ENVIRONMENT & RESULTS

To verify the effectiveness of the proposed system model for QoS management based on convergence layer, simulation is carried on MATLAB R2014b while considering Additive White Gaussian Noise (AWGN) as it depicts the effect of random processes that occur in nature. During the simulation process, the sensors offering dissimilar data rate were modeled that proposes different levels for reliability and priority requirements for different WBAN profiles i.e. ECG, EEG, EMG, Blood Pressure, Glucose Monitor, Blood Oxygen Saturation, Audio, Medical Imaging/Video according to varying patient's condition. The proposed simulation has defined three levels to identify reliability and priority requirements including high, average, and low values. To cater the priority of requesting sensors, capacity of a set of channels and different RATs i.e. Bluetooth, Zigbee, Ultra WideBand were aggregated to lessen the network delay time. To accommodate different reliability requests different modulation schemes were adopted as per availability in selected RAT. Bluetooth standard offers only one modulation scheme GMSK, while Zigbee has BPSK, OQPSK, and MPSK as available options. Moreover, UWB also provides different modulation schemes DBPSK ($\pi/2$), DQPSK ($\pi/4$), DPSK ($\pi/8$) to cater reliability requirements for requests entertained by UWB. The convergence layer of WBAN proposes high rate modulation schemes according to reliability request of a node. The chosen simulation parameters are listed in Table.5.

Table 6: Simulation Parameters

Simulation Parameters	
Simulation Tool	MATLAB
Channel	AWGN
WBAN Profiles	ECG, EEG, EMG, Blood Pressure, Glucose Monitor, Blood Oxygen Saturation, Audio, Medical Imaging/Video
Communication Technologies	Bluetooth, Zigbee, Ultra WideBand
Modulation Schemes	GMSK, BPSK, OQPSK, MPSK, DBPSK($\pi/2$), DQPSK($\pi/4$), DPSK($\pi/8$)
Simulation Time	30-60 min

A. Performance Metrics

Performance of the proposed system model for QoS management is evaluated based on the queuing delay, blocking probability, and throughput parameters as discussed below.

i. Queuing Delay

Average queuing delay represents an average of the delays experienced by all requests generated until channel allocation.

Eq.1 has shown the formula to calculate average queuing delay.

$$\text{Average Queuing Delay} = \frac{\sum(\text{Request Allocation Time} - \text{Request Generation Time})}{\text{Total Number of Requests.}}$$

..... Eq.1

ii. Blocking Probability

Blocking Probability defines the capacity of a system. It states how many users will be served effectively and forecasts what is the probability that the user will be get blocked. Eq.2 has presented the model to calculate the blocking probability. In the mentioned equation, n states number of channels, λ represents request arrival rate, and d highlights average request duration [48].

$$\text{Blocking Probability} = \text{erlang}(n, a) \text{}$$

Eq.2

Where the value of a is calculated based on " $a = \lambda * d$ " formula.

iii. Throughput

Throughput of the system is measured based on the channel aggregation. As for high priority profiles, channels are aggregated, it decreases the chances of packet drop and combined bandwidth enhances better transmission, hence increase in throughput. Different profiles are served in different scenarios as according to user priority different numbers of channels are assigned. For higher priority channels are aggregated thrice the user requirement as it allows the user to send data without any re-transmission and a wider transmission channel. In case of average priority twice of the actual need are allocated and for lower priority, no channel aggregation is done. In this way, different profiles are accommodated in different priority scenarios.

B. Simulation Results

i. Queuing Delay

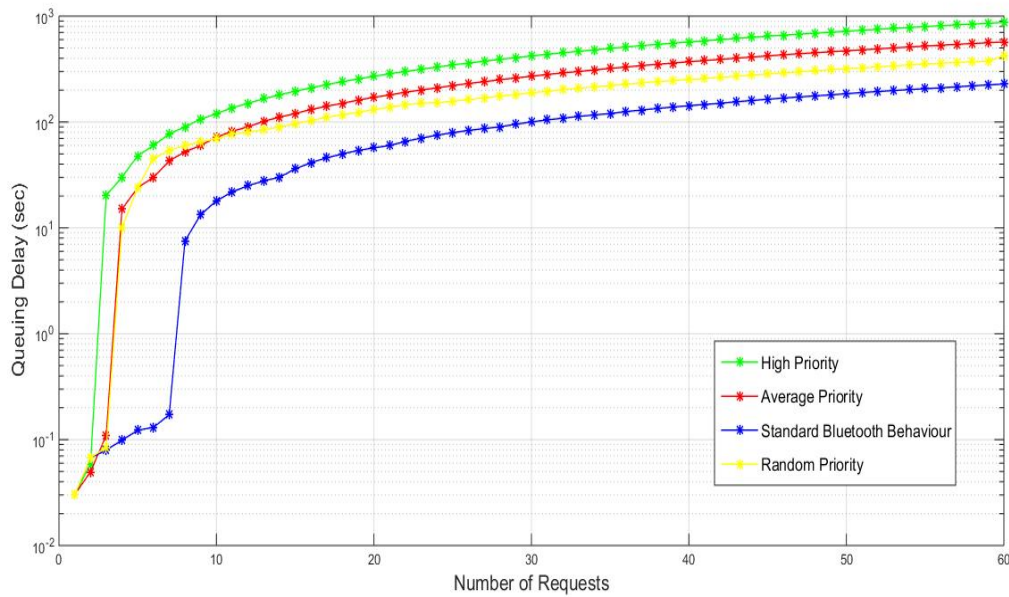

Fig 3: Delay Graph for Bluetooth

Fig.3 shows simulation results performed for 60 requests with an average profile time interval of 60 sec for four different scenarios having different data criticality levels: High, Average, Random, and Standard behavior of Bluetooth handling priority. The Bluetooth can serve 7 users at a time. Therefore, after 7th user, the queuing delay for standard Bluetooth priority setting is increased significantly but after a certain number of requests, the behavior becomes uniform. The same behavior is noticed for average and high priority case except a rise in queuing delay. The main reason for this behavior is due to allocating more channels to prioritize the requests to minimize the delay. Considering random priority scenario, performance of the proposed technique is better compared to average and high priority scenarios because of increase in number of requests. But, overall, channel aggregation affects the QoS for those requests that compete for a channel as it is first occupied by the high priority requests.

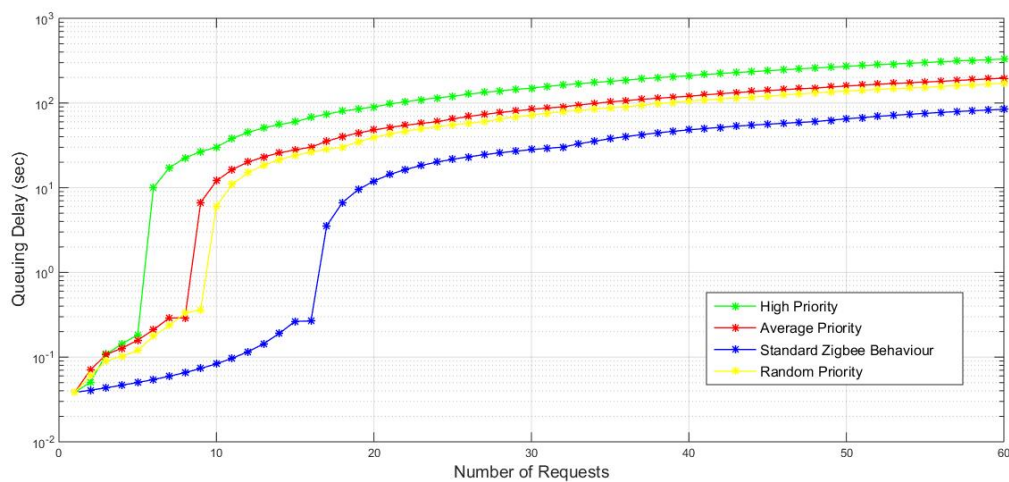

Fig 4: Delay Graph for Zigbee

Fig.4 depicts the simulation results performed for Zigbee with same profiles and scenarios are used. In the mentioned scenarios, high priority profiles mean critical data while red line representing average priority requirements depicts the results for moderate level of data criticality. As Zigbee has 16 frequency channels, after 16 the queuing delay for standard Zigbee is increased significantly. The same is the case while considering average and high priority scenarios except for an increase in queuing delays. As to serve the higher priority, more channels are allocated to the single user to ensure timely delivery.

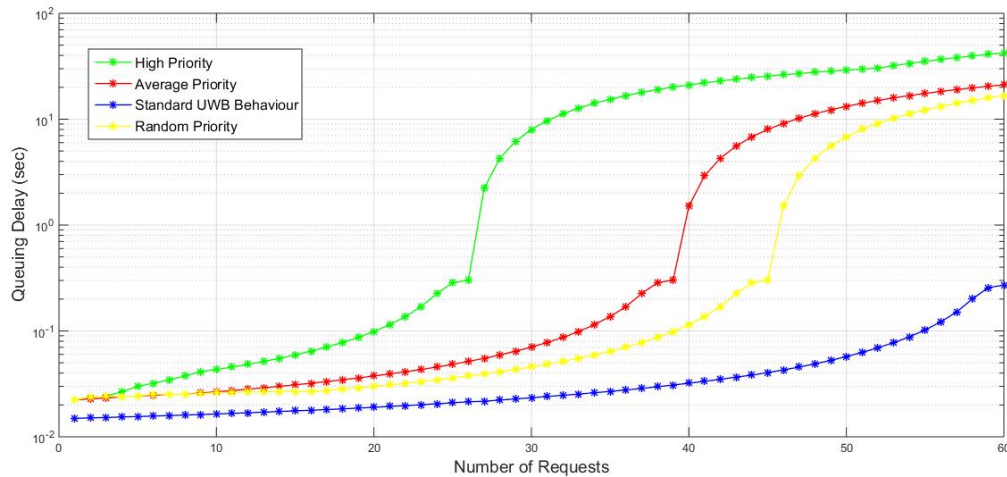

Fig 5: Delay Graph for UWB

Fig. 5 shows the result of simulations performed for 60 requests with average profile time interval of 60 sec for four different scenarios. For different priority levels include High, Average and Standard behavior of UWB handling priority. As UWB has 79 frequency channels in 2.4 GHz frequency band, after 79 the queuing delay for standard UWB is increased crucially but after a certain number of requests, the behavior becomes uniform.

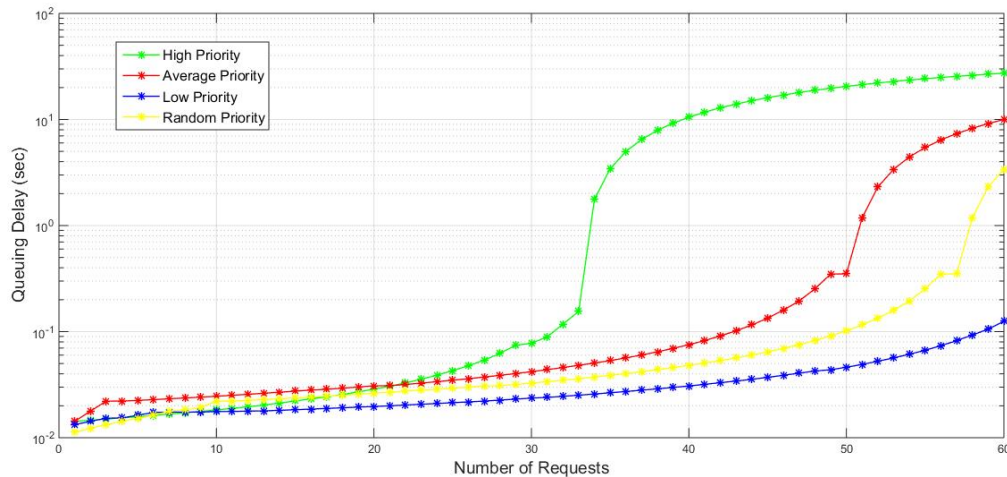

Fig 6: Delay Graph for Multi-RAT

Fig.6 depicts the delay experienced by the requests for high, average and low priority requests which is very less than the delay experienced by the requests using Single-RAT. As Bluetooth depicts a crucial behavior in delay after seven users are served. Same is the case for Zigbee and UWB because they have lesser resources/channels to accommodate resources as compared to Multi-RAT.

ii. Number of Requests-Channel Capacity

Fig.7 is showing the number of requests that can be accommodated by different technologies having different coverage area. As UWB operates in the area of 5 meters, a user within 5-meter range can utilize all the radio access technologies. However, when a user moves beyond range of 5 meters (less than 10), the proposed scheme will communicate through Bluetooth and Zigbee technologies. Alternatively, if a user crosses the range of 10 meters, then Zigbee will be the last available option to serve the user requirements. Simulations are performed for different priority scenarios and different available transmission technologies. In Fig.7 random priority block shows the averaging of the results of different priority requirements while other block shows the static behavior of the system against different type of priority requirements. Bluetooth and Zigbee have lesser number of channels as compared to UWB that's why lesser number of requests is entertained by Bluetooth and Zigbee as mentioned in Table.4. The result's behavior has shown that UWB, Zigbee, and Bluetooth has shown 21%, 20%, and up to 95% fewer requests compared to the hybrid of Zigbee, Bluetooth, and UWB for $p=Low$ selection.

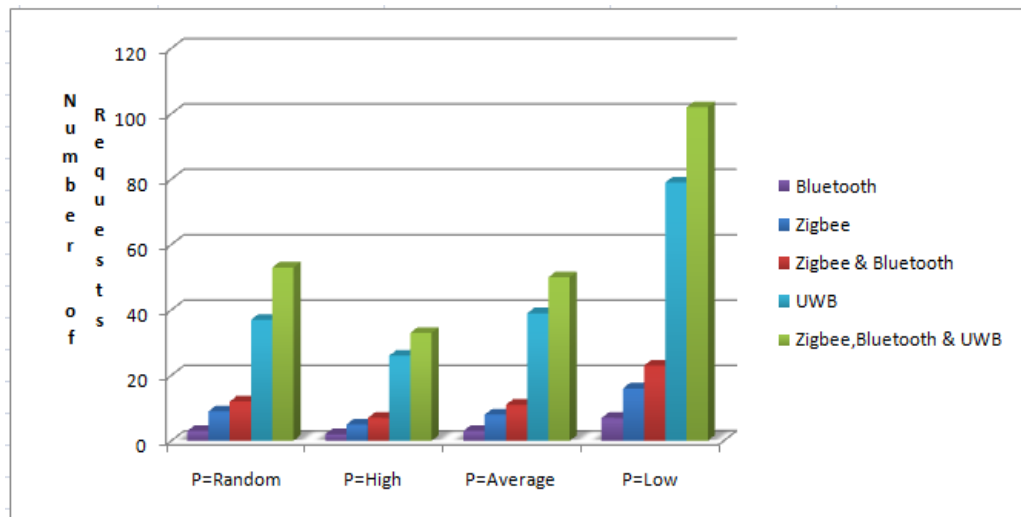

Figure 7: Number of Requests Served

iii. Blocking Probability

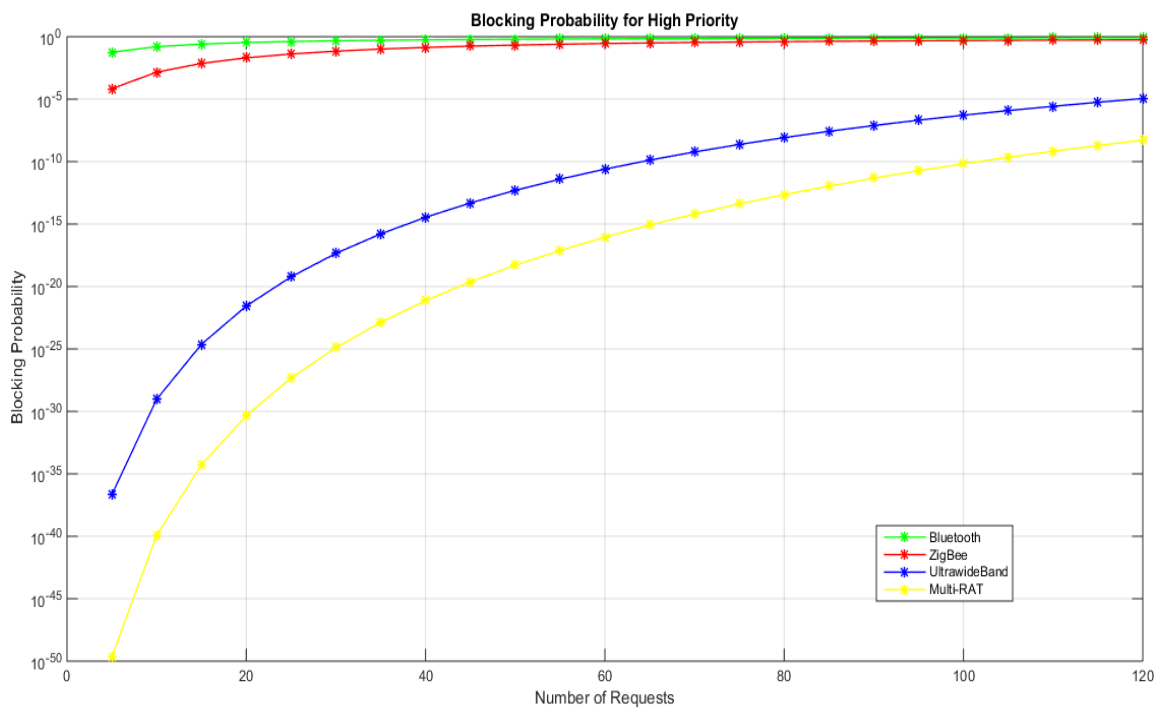

Fig 8: Blocking Probability for High Priority Requests

Fig.8 plots blocking probability against number of requests. Blocking probability of requests increases as the number of requests surges. For the Bluetooth and Zigbee, blocking probability of the requests is much higher compared to the UWB. However, considering proposed scheme, multi-RAT's blocking probability is very low for the starting 20 requests; but, after 20 requests, probability increases due to blocking of new requests due to channel occupation. Considering low and average priority requests, the proposed scheme allocates less number of channels. As a result, the chance of a request being block reduces as each user acquires less resource.

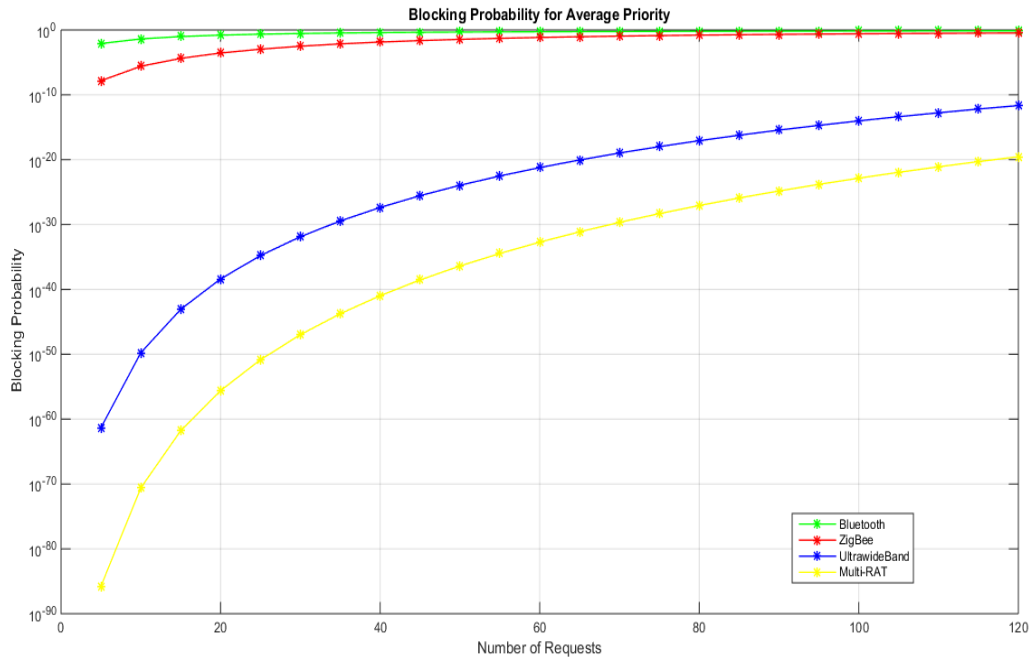

Fig 9: Blocking Probability for Average Priority Requests

Fig.9 shows a slight decrease in blocking probability for average priority requests as for requests having average data criticality level are assigned less resources as compared to higher priority requests.

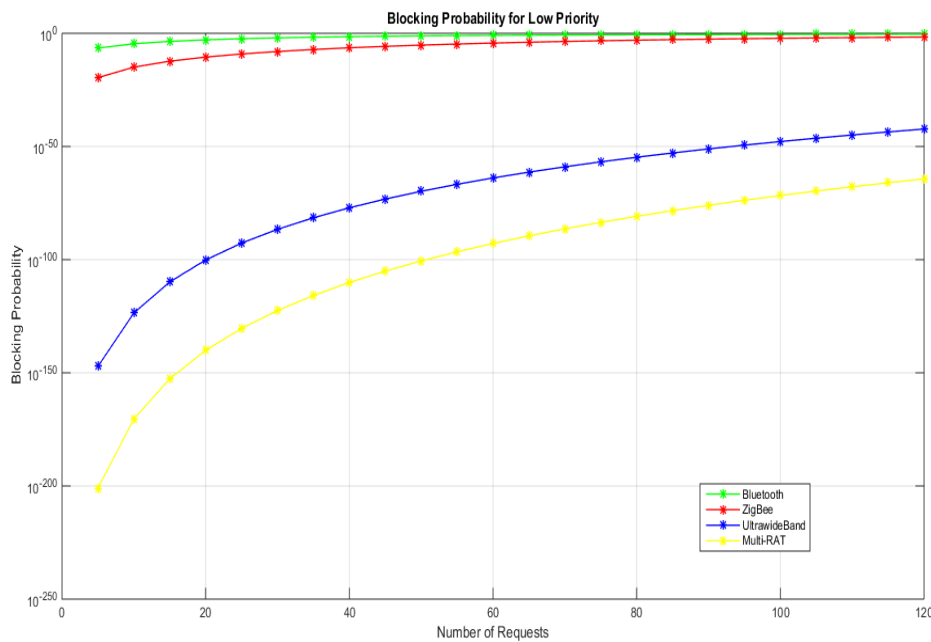

Fig 10: Blocking Probability for Low Priority Requests

Fig. 10 depicts the blocking probability of requests when number of requests increases. In this case, behavior of the graph is a little different and surprising compared to average and high priority. The main reason for this behavior is this that in low priority more requests are facilitated. It is noticed that blocking probability of the requests using Bluetooth and Zigbee is higher than UWB. Also for proposed scheme, multi-RAT blocking probability is very low when number of requests are 80 only because multi-RAT has a collection of resources to facilitate a number of requests. It can also be seen that the blocking probability of Multi-Rat is almost $2.6 e^{-140}$

times lower than UWB technology. Similarly, for Bluetooth and ZigBee it is $9.96 e^{-87}$ and $1e^{-87}$ times lower when considering blockage probability for 40 number of requests.

5.0 CONCLUSION

In this paper, we have proposed a convergence layer which caters the QoS problems of WBAN by offering an adaptive priority solution depending on the criticality of the application and sensor data rate. It increases throughput thrice of the traditional approach as it works on channel aggregation. By aggregation of channels for a critical data requests, queuing delay increases as a single user is facilitated with multiple resources. While on another side, multi-RAT architecture helps to use different technologies to serve user's requests that as a result, decrease queuing delay. It provides adaptive reliability depending on the nature of WBAN profile and channel quality information. Hence, it increases the chance of packet delivery ratio. The proposed solution can also benefit multiple users at a time in intra-BAN and serve more WBAN profiles while minimizing queuing delay.

Further enhancements can be made to the system to make it more reliable while considering different error detection and correction schemes i.e. Forward Error Correction, Reed Solomon and Cyclic Redundancy Check.

REFERENCES

- [1] Sana Ullah, Pervez Khan, Niamat Ullah, Shahnaz Saleem, Henry Higgins, and Kyung Sup Kwak, "A Review of Wireless Body Area Networks for Medical Applications", International Journal of Communications, Network and System Sciences (IJCNS), Vol.2, No.8: 797-803) August 2009.
- [2] C. Otto, A. Milenkovic, C. Sanders, and E. Jovanov, "System architecture of a wireless body area sensor network for ubiquitous health monitoring," Journal of Mobile Multimedia, vol. 1, no. 4, pp. 307-326, 2006.
- [3] Joonyoung Jung, "Wireless Body Area Network in a Ubiquitous Healthcare System for Physiological Signal Monitoring and Health consulting", International Journal of Signal Processing, Image Processing and Pattern Recognition, 2008.
- [4] P. S. Pandian, "Wireless Sensor Network for Wearable Physiological Monitoring", Journal of Networks, Vol. 3, No. 5, May 2008.
- [5] <http://www.healio.com/cardiology/learn-the-heart/ecg-review/ecg-interpretation-tutorial/approach-to-ecg-interpretation>
- [6] S. A. Makhin, V. B. Pavlenko, "EEG Activity in the Process of Measuring-off of Time Intervals by Humans", Neurophysiology, Volume 35, Issue 2, pp 143-148, March 2003.
- [7] Kazuo Eguchia, Sujith Kuruvillab, Gbenga Ogedegbeb, William Gerinb, Joseph E. Schwartzc, and Thomas G. Pickeringb, "What is the optimal interval between successive home blood pressure readings using an automated oscillometric device? ", J Hypertens. 2009 June; 27(6): 1172–1177.
- [8] Gruber P, Kwiatkowski T, Silverman R, Flaster E, Auerbach C, "Time to equilibration of oxygen saturation using pulse oximetry", Acad Emerg Med. 1995 Sep;2(9):810-5.
- [9] http://www.walgreens.com/images/pdfs/library/diabetes/glucose_meter_comparison_chart.pdf
- [10] Soylu AR, Arpinar-Avsar P, "Detection of Surface Electromyography Recording Time Interval Without Muscle Fatigue Effect for Biceps Brachii Muscle During Maximum Voluntary Contraction", J Electromyogr Kinesiol, August 2010.
- [11] <http://www.biotrack.co.uk/pdf/sensetemp.pdf>
- [12] M. Charles Liberman, Leslie D. Liberman, and Stéphane F. Maison, "Efferent Feedback Slows Cochlear Aging", J Neurosci. 2014 Mar 26; 34(13): 4599–4607.

- [13] Chinmay Chakraborty, Bharat Gupta, and Soumya K. Ghosh, “A Review on Telemedicine-Based WBAN Framework for Patient Monitoring”, *Telemed J E Health*. 2013 Aug; 19(8): 619–626.
- [14] Elli Kartsakli, Aris S. Lalos, Angelos Antonopoulos, Stefano Tennina, Marco Di Renzo, Luis Alonso, and Christos Verikoukis, “A Survey on M2M Systems for mHealth: A Wireless Communications Perspective”, *Sensors (Basel)*. 2014 Oct; 14(10): 18009–18052.
- [15] P. S. Pandian, “Wireless Sensor Network for Wearable Physiological Monitoring”, *JOURNAL OF NETWORKS*, VOL. 3, NO. 5, May 2008.
- [16] D. Raskovic, T. Martin and E. Jovanov, “Medical monitoring applications for wearable computing”, *The Computer Journal*, vol. 47, no.4. 2004, pp.495-504.
- [17] S. Park and S. Jayaraman, “Enhancing the quality of life through wearable technology,” *IEEE Engineering in Medicine and Biology Magazine*, vol. 22, no. 3, pp. 41-48, May/June. 2003.
- [18] Emil Jovanov, et al., 2011. *Body Area Networks for Ubiquitous Healthcare Applications: Opportunities and Challenges*, *J Med Syst*(2011) 35:1245-1254.
- [19] B. Gyselinckx, R. Vullers, C. V. Hoof, J. Ryckaert, R. F.Yazicioglu, P. Fiorini, and V. Leonov, “Human: Emerging technology for body area networks,” in *Very Large Scale Integration, IFIP International Conference on*, Oct. 2006, pp. 175-180.
- [20] Kamya Yekeh Yazdandoost, Kamran Sayrafian-Pour, “Channel Model for Body Area Network (BAN) : IEEE P802.15 Wireless Personal Area Networks”, 2009.
- [21] C. C. Y. Poon, Y.-T. Zhang, and S.-D. Bao, “A novel biometrics method to secure wireless body area sensor networks for telemedicine and m-health”, *IEEE Communications Magazine*, vol. 44, no. 4, pp. 73-81, Apr. 2006.
- [22] J. Yoon, G.-S. Ahn, S.-S. Joo and M. Lee, “Pnp-mac: Preemptive slot allocation and non-preemptive transmission for providing QoS in body area networks,” in *Proc. of Consumer Communications and Networking Conference*, pp.1–5, Jan.2010.
- [23] Khaled A. Ali, Jahangir H. Sarker, and Hussein T. Mouftah, “QoS-based MAC protocol for Medical Wireless BodyArea Sensor Networks”, *School of Information Technology and Engineering University of Ottawa, Ottawa, IEEE Communication magazine*, 2010.
- [24] H. Cao, S. Gonza andlez Valenzuela and V.Leung, “Employing ieee 802.15.4 for quality of service provisioning in wireless body area sensor networks,” in *Proc. of Advanced Information Networking and Applications*, pp.902–909, Apr.2010.
- [25] M. Barua, M. Alam, X. Liang and X. Shen, “Secure and quality of service assurance scheduling scheme for wban with application to ehealth,” in *Proc. of Wireless Communications and Networking Conference*, pp.1102–1106, Mar.2011.
- [26] ShihHeng Cheng, ChingYao Huang, Chun Chen Tu, “RACOON: A Multiuser QoS Design for Mobile Wireless Body Area Networks”, *Springer*, 2011.
- [27] Muhammad Mostafa Monowar, Mohammad Mehedi Hassan, Fuad Bajaber, Musaed Al-Hussein and Atif Alamri, “McMAC: Towards a MAC Protocol with Multi-Constrained QoS Provisioning for Diverse Traffic in Wireless Body Area Networks”, *Sensors*, 2012.
- [28] Mohsin Iftikhar, Iftikhar Ahmad, “A Novel Analytical Model for Provisioning QoS in Body Area Sensor Networks”, *2nd International Workshop on Body Area Sensor*, *Procedia, Elsevier*, 2014.
- [29] Smita Bhoir, Amarsinh Vidhate, “An Improved WBAN MAC Protocol”, *International Conference on Computer Communication and Informatics (ICCCI-2014)IEEE Communication Magazine*, Coimbatore, India, Jan. 03 – 05, 2014.

- [30] Keyoung hur, “A Hierarchical MAC Protocol for QoS Support in Wireless Wearable Computer Systems” , Department of Computer Education, Gyeongin National University of Education, Korea ,Journal of Information and Communication Convergence Engineering , IEEE 430-739, 2014.
- [31] Madhumita Kathuria, Sapna Gambhir, “Transport Layer Protocol for WBAN system”, International Conference on Reliability, Optimization and Information Technology, India, IEEE Communication Magazine ,Feb 2014.
- [32] Flavia Martelli, Roberto Verdone, Chiara Buratti, “Link Adaptation in Wireless Body Area Networks”, DEIS, University of Bologna, Italy, 2011.
- [33] Mohammad Sadegh Mohammadi, Eryk Dutkiewicz, Qi Zhang, and Xiaojing Huang, “Optimal Energy Efficiency Link Adaptation in IEEE 802.15.6 IR-UWB Body Area Networks”, IEEE Communication Letters, Vol. 18, NO. 12, December 2014.
- [34] Tuomas Paso, Ville Niemela, Jussi Haapola and Jari Iinatti, “Novel Modulation Adaptation Techniques for IEEE 802.15.4a UWB System”, Centre for Wireless Communications, University of Oulu, Finland.
- [35] M. S. Akbar, H. Yu, and S. Cang, “Delay, Reliability, and Throughput Based QoS Profile : A MAC Layer Performance Optimization Mechanism for Biomedical Applications in Wireless Body Area Sensor Networks” , 2016.
- [36] N. Javaid, M. Yaqoob, M. Y. Khan, M. A. Khan, A. Javaid, and Z. A. Khan, “Analyzing Delay in Wireless Multi-hop Heterogeneous Body Area Networks.”, 2013.
- [37] Long Hu, Yin Zhang, Dakui Feng, Mohammad Mehedi Hassan, Abdulhameed Alelaiwi, Atif Alamri, “Design of QoS-Aware Multi-Level MAC-Layer for Wireless Body Area Network”, *Journal of Medical Systems*, 39(12), 2015.
- [38] Sabin Bhandari and Sangman Moh, “A Priority-Based Adaptive MAC Protocol for Wireless Body Area Networks”, *Sensors*, 16(3).401, 2016.
- [39] Yangzhe Liao , Mark S. Leeson , Matthew D. Higgins and Chenyao Bai, “Analysis of In-to-Out Wireless Body Area Network Systems: Towards QoS-Aware Health Internet of Things Applications” , *Electronics*, 5(3), 38, 2016.
- [40] Farhan Masud, Abdul Hanan Abdullah, Gaddafi Abdul-Salaam, Fasee Ullah, “Traffic adaptive MAC protocols in wireless body area networks”, *Wireless Communications and Mobile Computing*, 2017.
- [41] Jaeho Lee and Seungku Kim, “Emergency-Prioritized Asymmetric Protocol for Improving QoS of Energy-Constraint Wearable Device in Wireless Body Area Networks”, *Applied Sciences*, 8(1), 92, 2018.
- [42] M. D. Nisar, V. Pauli, and E. Seidel, “Multi-RAT Traffic Steering – Why, when , and how could it be beneficial ?,” pp. 1–7, 2011.
- [43] S. Singh, S. Yeh, N. Himayat, and S. Talwar, “Optimal Traffic Aggregation in Multi-RAT Heterogeneous Wireless Networks”, 2016.
- [44] A. Bazzi, “On Uncoordinated Multi User Multi RAT Combining”, 2011 IEEE Veh. Technol. Conf. (VTC Fall), pp. 1–6, 2011.
- [45] S. Goyal, T. Le, A. Chincholi, T. Elkourdi, A. Demir, S. Goyal, T. Le, A. Chincholi, T. Elkourdi, and A. Demir, “On the packet allocation of Multi-Band Aggregation Wireless Networks.” ,2015.
- [46] Y. Fu, L. Ma, and Y. Xu, “A Novel Component Carrier Configuration and Switching Scheme for Real-Time Traffic in a Cognitive-Radio-Based Spectrum Aggregation System,” pp. 23706–23726, 2015.
- [47] A. Gudipati and S. Katti, “Automatic Rate Adaptation,” 2010.
- [48] M. Zafer and E. Modiano, “Blocking probability and channel assignment in wireless networks,” IEEE Transactions on Wireless Communications, Vol. 5, No. 4, April 2006.